

GV-TDR2700 Series 2MP H.265 Low Lux WDR Pro IR Mini Fixed Rugged IP

Dome



- 1/2.8" progressive scan low lux CMOS sensor
- Triple streams from H.265, H.264 or MJPEG
- Up to 30 fps at 1920 x 1080
- Intelligent IR
- IR distance up to 30 m (100 ft)
- Day and night function (with removable IR-cut filter)
- 3-axis mechanism (pan / tilt / rotate)
- Ingress protection (IP67)
- Vandal Resistance (IK10 for metal casing)
- Built-in micro SD card slot (SD / SDHC / SDXC / UHS-I, Class 10) for local storage
- Two-way audio
- 1 sensor input and 1 alarm output
- DC 12V / PoE (IEEE 802.3af)
- Wide Dynamic Range Pro (WDR Pro)
- Defog
- 3D noise reduction
- Motion detection
- Text overlay
- Privacy mask
- ONVIF (Profile G, S, T) conformant

Introduction

The Mini Fixed Rugged IP Dome is an outdoor, fixed, network camera equipped with an automatic IR-cut filter and an IR LED for day and night surveillance. The camera supports H.265 video codec to achieve better compression ratio while maintaining high quality pictures at reduced network bandwidths. The camera adheres to IP67 and IK10 standards, and can be powered through PoE.

Models

Model	Iris	Focal Length (mm)	Maximum Aperture	Image Format
GV-TDR2700-0F	Fixed	2.8	F/1.6	1/2.8"
GV-TDR2700-1F	Fixed	4.0	F/1.6	1/2.8"

Dimensions

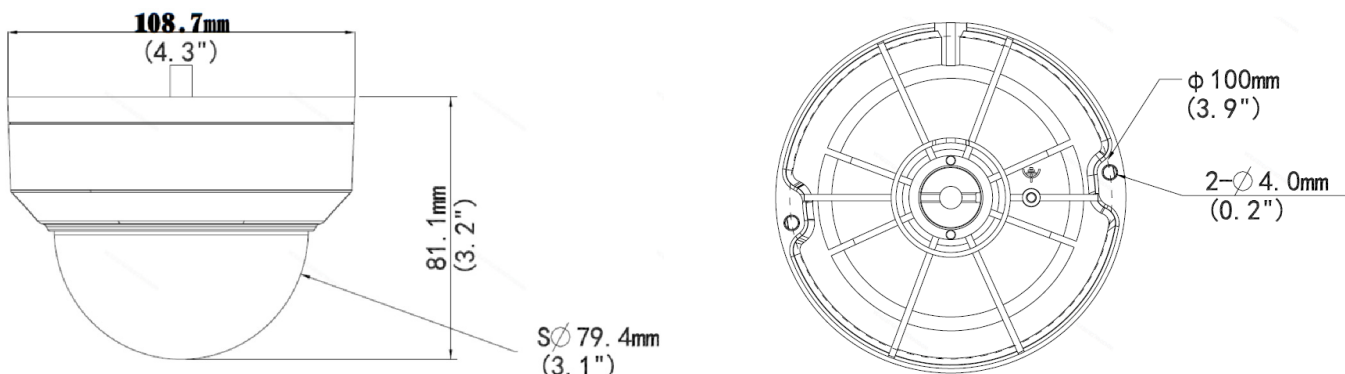

Specifications

Camera		
Image Sensor	1/2.8" progressive scan low lux CMOS	
Picture Elements	1920 (H) x 1080 (V)	
Minimum Illumination	Color	0.001 Lux (F1.6, AGC ON)
	IR ON	0 Lux
Shutter Speed	Auto / Manual (1 ~ 1/100000 sec)	
White Balance	Auto / Manual	
Gain Control	Auto / Manual	
S/N Ratio	52 dB	
WDR Pro	Yes	
Dynamic Range	120 dB	
Lens		
	GV-TDR2700-0F	GV-TDR2700-1F
Megapixel	Yes	
Day / Night	Yes (with removable IR-cut filter)	
Lens Type	Fixed	
Focal Length	2.8 mm	4.0 mm
Maximum Aperture	F/1.6	
Mount	M12	
Horizontal FOV	111°	81°
Operation	Focus	Fixed
	Zoom	Fixed
	Iris	Fixed
IR LED Quantity	1 IR LED	
Max. IR Distance	30 m (100 ft)	
Operation		
Video Compression	H.265, H.264, MJPEG	
Video Streaming	Triple streams from H.265, H.264 or MJPEG	
Video Resolution	Main Stream	1920 x 1080 (Default), 1280 x 720
	Sub Stream	1920 x 1080, 1280 x 720, 720 x 576, 704 x 288, 640 x 360 (Default), 352 x 288
	Third Stream (Closed by Default)	720 x 576, 704 x 288, 640 x 360, 352 x 288
Frame Rate	30 fps at 1920 x 1080 (60 / 50 Hz) * The frame rate and performance may vary depending on the number of connections and data bitrates (different scenes).	
Video Analytics	Motion Detection, Tampering Alarm, Audio Detection, Cross Line, Intrusion, Object Moving, Object Left, Defocus, Scene Change, Face Detection, People Counting *Tampering alarm, audio detection, cross line, intrusion, object moving, object left, defocus, scene change, face detection and people counting are only accessible through the camera's Web interface, which can be used to trigger alerts such as e-mail and FTP	
Image Setting	Brightness, Contrast, Saturation, Sharpness, Flicker-less, Image Orientation	
Audio Compression	G.711, AAC (optional)	
Audio Support	Two-way audio (external microphone and speaker required)	
Digital I/O	Input	1 Input, dry contact, NO / NC
	Output	1 Relay Output (1A 30V DC / 0.3A 125V AC)
Network		
Interface	10/100 Ethernet	
Protocol	802.1x, ARP, DHCP, DDNS, DNS, DynDNS, FTP, HTTP, HTTPS, ICMP, IGMP, IPv4, NTP, PPPoE, QoS, RTCP, RTP, RTSP, SMTP, SNMP, TCP, UDP, UPnP, ONVIF (Profile G, S, T)	
Mechanical		
Temperature Detector	No	
Camera Angle Adjustment	Pan	0° ~ 360°
	Tilt	0° ~ 75°
	Rotate	0° ~ 360°

Connectors	Power	DC Jack (DC 12 V, 1.25 A), PoE
	Ethernet	RJ-45 connector
	Audio	2 in (Audio In Wire); 1 out (Audio Out Wire) *The Audio In port only support microphones with power supply.
	Digital I/O	I/O wires
	Local Storage	Micro SD card slot (SD / SDHC / SDXC / UHS-I, Class 10) *UHS-II card type is not supported.
General		
Operating Temperature	-35°C ~ 60°C (-31°F ~ 140°F)	
Humidity	0% ~ 95% (no condensation)	
Power Source	12 V DC / PoE (IEEE802.3af)	
Max. Power Consumption	4 W	
Dimensions	Ø 108.7 x 81.1 mm (Ø4.3" x 3.2")	
Weight	0.45 kg (0.99 lb)	
Ingress Protection	IP67	
Vandal Resistant	IK10 for metal casing	
Regulatory	FCC, CE, RoHS compliant	
Web Interface		
Installation Management	Web-based configuration	
Maintenance	Firmware upgrade through Web Browser or Utility	
Access from Web Browser	Live View, Video Recording, Change Video Quality, Bandwidth Control, Image Snapshot, Defog, Text Overlay, Image Masking	
Language	Czech, English, French, German, Hungarian, Italian, Japanese, Polish, Portuguese, Russian, Spanish, Traditional Chinese	
Applications		
Software Supported	GV-DVR / NVR (V8.7.6), GV-VMS (V17.1.0.100), GV-Control Center (V3.5.1), GV-Edge Recording Manager Win Version (V1.3.0.0), GV-Recording Server / Video Gateway (V1.4.1), GV-Redundant / Failover Server (V1.1.0.0), GV-Mobile Server (V1.5.0.0)	
Smart Device Access	GV-Eye for iOS and Android	
Live Viewing	Browser (IE, Edge, Chrome, Firefox, Safari), Mobile App	



Note:





1. It is required to apply patch files to all the supported software.
2. Do not use clothes or any ordinary material to clean the camera cover since they may result in scratches.
3. Specifications are subject to change without notice.

Packing List

- | | |
|--|--------------------------|
| 1. GV-TDR2700 IR Mini Fixed Rugged IP Dome | 4. Drill Template Paster |
| 2. Waterproof Rubber Set | 5. Download Guide |
| 3. Screw Kit | 6. Warranty Card |

Accessories

Model No.	Name		Details
GV-Mount107 (must be used with GV-Mount213)	Pendant Bracket		Dimensions: Ø 120 x 334 mm (Ø 4.72" x 13.15") Weight: 0.74 kg (1.63 lb)
GV-Mount211P	Wall Mount Bracket		Dimensions: Ø 233 x 126 x 126 mm (Ø 9.2" x 5" x 5") Weight: 1 kg (2.2 lb)
GV-Mount213	Wall / Ceiling Box Mount		Dimensions: Ø 109 x 39 mm (Ø 4.3" x 1.5") Weight: 0.2 kg (0.44 lb)

Model No.	Name		Details
GV-Mount300-2	Convex Corner Mount		Dimensions: 137 x 233 x 160 mm (5.4" x 9.17" x 6.3") Weight: 1.65 kg (3.64 lb)
GV-Mount310-2	Concave Corner Mount		Dimensions: 111.2 x 369.9 x 210 mm (2.6" x 11.4" x 6.6") Weight: 1.65 kg (3.64 lb)
GV-Mount420 (must be used with GV-Mount211P)	Pole Mount Bracket		Dimensions: \varnothing 120 x 120 x 53.4 mm (\varnothing 4.7" x 4.7" x 2.1") Weight: 0.45 kg (0.99 lb) Steel Strap Diameter: \varnothing 67 ~ 127 mm (\varnothing 2.6" ~ 5")
GV-Mount704 (must be used with GV-Mount107)	Extension Tube		Dimensions: \varnothing 3.5 x 10 or 20 or 30 or 50 cm (\varnothing 1.38 x 3.9 or 7.9 or 11.8 or 19.7") Weight: 225g or 360g or 500g or 780g (0.5 lb or 0.79 lb or 1.1 lb or 1.72 lb)
GV-PA191	Power over Ethernet (PoE) Adapter		GV-PA191 is a Power over Ethernet (PoE) adapter designed to provide power to the IP device through a single Ethernet cable.
GV-PoE Switch			GV-PoE Switch is designed to provide power along with network connection for IP devices. GV-PoE Switch is available in various models with different numbers and types of ports.
Power Adapter			Contact our sales representatives for the countries and areas supported.