

GV-VD8700 8MP H.265 Low Lux WDR IR Vandal Proof IP Dome



- 1/2.5" progressive scan low lux CMOS
- Min. illumination at 0.04 lux
- Triple streams from H.265 and H.264
- Up to 30 fps at 3840 x 2160
- Vandal resistance (IK10)
- Ingress protection (IP66)
- Megapixel varifocal lens
- P-iris lens for auto iris control
- Day and Night function (with removable IR-cut filter)
- Intelligent IR
- Wide Dynamic Range (WDR)
- IR distance of up to 40 m (130 ft)
- 3-axis mechanism (pan / tilt / rotate)
- One sensor input and digital output
- Built-in micro SD card slot (SD/SDHC/SDXC/UHS-I, Class 10) for local storage
- DC 12V / PoE (IEEE 802.3af)
- One-way audio
- Defog
- Motion detection
- Tampering alarm
- Face recognition
- Text overlay
- Privacy mask
- IP address filtering
- Recording assigned by GV-Edge Recording Manager ([Windows & Mac](#))
- Supports iPhone, iPad, and Android
- 4 languages on Web interface
- ONVIF (Profile S) conformant

* No memory card slot & local storage function for Argentina

Introduction

GV-VD8700 Vandal Proof IP Dome camera features cutting-edge face recognition technology that allows users to identify important personnel from its database, on the fly. Up to 10,000 face profiles can be defined in the camera's database, and also categorized to meet various corporate needs, such as facilitating customer service or security management and more. The camera's face recognition mechanism is effective for a distance of up to 4 m (14 ft) while able to identify up to 10 persons simultaneously. With a recognition time of within 2 seconds, it can quickly identify VIP guests and/or potential intruders. When integrated with GV-VMS, GV-VD8700's face recognition can be used to trigger alerts according to the predefined rules, thereby providing an improved, reliable security management.

As an outdoor camera, GV-VD8700 is designed with IK10 vandal resistance and IP66 ingress protection. The camera can support H.265 video codec to achieve better compression ratio while maintaining high-quality pictures at reduced network bandwidths. For night operations, the camera is equipped with an IR effective distance of up to 40 m (130 ft). Its WDR and Backlight Compensation allow the camera to detect faces in environments with drastic light contrast.

Real-time Face Recognition on Live View

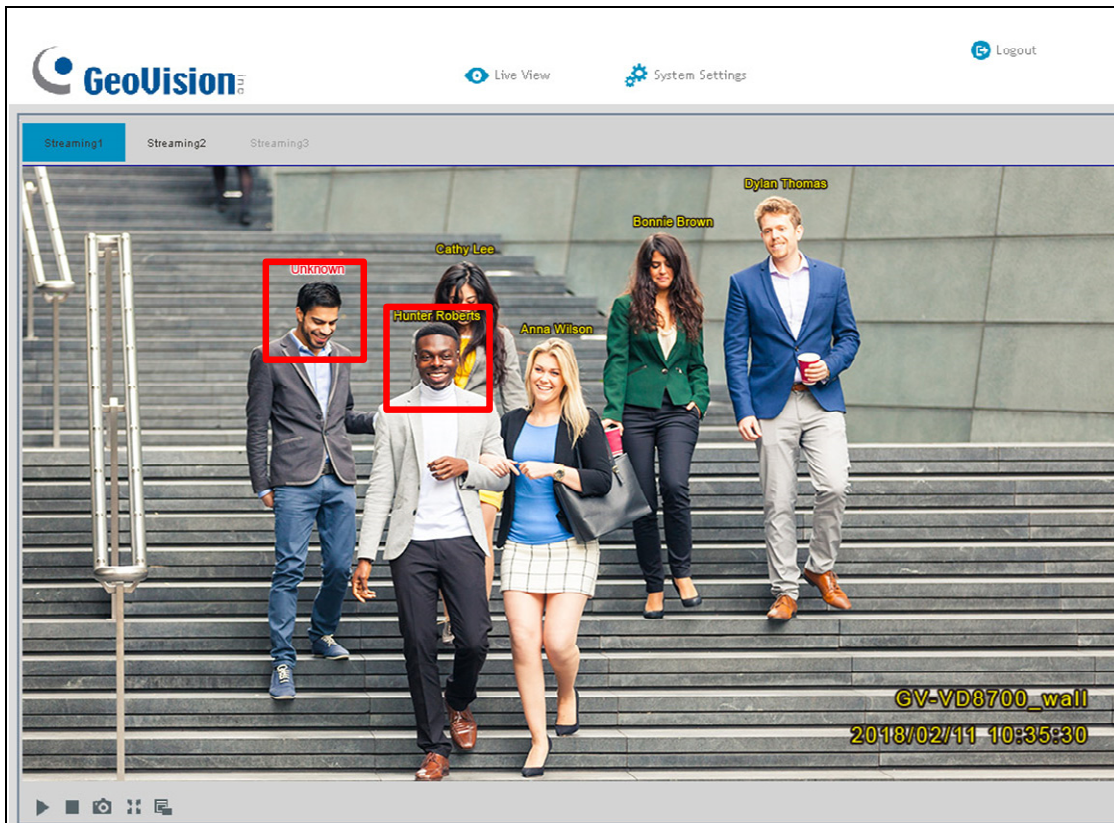

Retrieval Face Events

Setting License Management Events						
2018/02/10 21:47:50		~ 2018/02/11 21:47:50		Query	<input type="checkbox"/> Auto Polling 10	<input type="checkbox"/> Advance Search
Show 10 entries						
Timestamp	Name	Image	Conf0	Conf1	Conf2	
Sunday, February 11, 2018 10:44:55	Unknown		Mark_Lin 51	Peter_Liu 44.2	Ray_Su 43.2	
Sunday, February 11, 2018 10:35:50	Cathy Lee		Cathy_Lee 57.3	Zach_Lin 48.9	Kylin_Lin 44.3	
Sunday, February 11, 2018 10:48:35	Hunter Roberts		Hunter_Roberts 55.9	Peter_Liu 54.6	Ray_Su 49.9	
Sunday, February 11, 2018 10:47:57	Anna Wilson		Anna Wilson 57.3	Daniel_Chung 42.4	Mars_Lin 40.4	
Sunday, February 11, 2018 10:49:51	Bonnie Brown		Bonnie Brown 64.9	Mark_Lin 48.3	Kim_Lu 41.7	
Sunday, February 11, 2018 10:49:43	Dylan Thomas		Dylan Thomas 58.5	Cesar_Liu 40.6	York_Yang 37.8	

Active Tampering Alarm

Tampered



Focus Change



Camera Shift



Dimensions

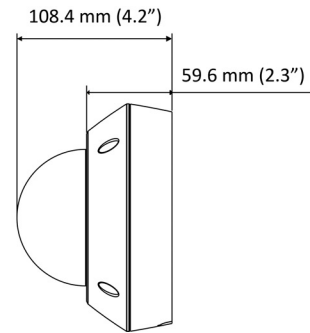
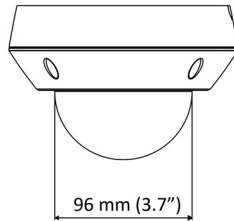
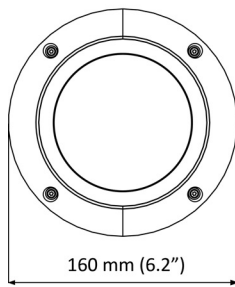

Specifications

Camera		
Image Sensor	1/2.5" progressive scan low lux CMOS	
Picture Elements	3840 (H) x 2160 (V)	
Minimum Illumination	Color	0.05 Lux
	B/W	0.04 Lux
	IR ON	0 Lux
Shutter Speed	Automatic, Manual (1/30 ~ 1/8000 sec.)	
White Balance	Automatic, Manual (2800K ~ 8500K)	
Gain Control	Automatic	
S/N Ratio	56 dB	
WDR	Yes	
Dynamic Range	96 dB	
Lens		
Megapixel	Yes	
Day/Night	Yes (with removable IR-cut filter)	
Focal Length	3.3 ~ 12 mm	
Lens Type	Varifocal	
Maximum Aperture	F/1.4	
Mount	Ø14 mm	
Horizontal FOV	106° ~ 42°	
Image Format	1/2.5"	
Operation	Focus	Manual (with lock)
	Zoom	Manual (with lock)
	Iris	P-iris
IR LED Quantity	20 IR LEDs	
Max. IR Distance	40 m (130 ft)	
Face Recognition		
Environment	600 lux	
Recognition face angle	Tilt (Up/Down)	± 15°
	Swing (Left/Right)	± 15°
Max. No of Faces	Up to 10	
Min. face image pixel requirement	120 x 120	

Operation		
Video Compression	H.265, H.264	
Video Streaming	Stream 1 from H.265 or H.264 Stream 2 from H.264 Stream 3 from H.264	
Frame Rate	30 fps at 3840 x 2160 (50 / 60 Hz) * The frame rate and the performance may vary depending on the number of connections and data bitrates (different scenes).	
Image Setting	Brightness, Contrast, Saturation, Sharpness, White Balance, Flicker-less, Image Orientation, Shutter Speed, D/N Sensitivity, Backlight Compensation, WDR, Defog	
Video Analytics	Motion Detection, Tampering Alarm, Face Detection, Face Recognition	
Audio Compression	G.711, AAC (Optional)	
Audio Support	One-way audio	
Sensor Input	1 input (Dry contact)	
Alarm Output	1 digital output (200 mA 5V DC)	
Intelligent Video		
Video Analytics	Motion Detection, Tampering Alarm, Face Detection, Face Recognition	
Video Resolution		
Main Stream	4:3	2560 x 1920, 2048 x 1536, 1600 x 1200, 1280 x 960
	16:9	3840 x 2160 (Default), 2560 x 1440, 1920 x 1080, 1280 x 720
Sub Stream	4:3	1024 x 768, 640 x 480, 320 x 240
	16:9	1280 x 720, 640 x 360 (Default)
Third Stream	4:3	640 x 480, 320 x 240
	16:9	640 x 360 (Default)
Network		
Interface	10/100 Ethernet	
Ethernet Protocol	DHCP, DynDNS, FTP, HTTP, HTTPS, NTP, ONVIF (Profile S), RTSP, SMTP, TCP, UDP	
Mechanical		
Temperature Detector	Yes	
Camera Angle Adjustment	Pan	0° ~ 350°
	Tilt	0° ~ 75°
	Rotate	0° ~ 340°
Connectors	Power	2-pin terminal block (DC 12V, 3A), PoE
	Ethernet	Ethernet (10/100 Base-T), RJ-45
	Audio	1 In (built-in or 3.5 mm phone jack for external microphone with power supply) 1 Out (3.5 mm phone jack for speaker) (Currently not functional)
	Digital I/O	I/O wires
	Local Storage	Micro SD card slot (SD/SDHC/SDXC/UHS-I, Class 10) *UHS-II card type is not supported.
LED Indicator	2 LEDs: Power, Status	
General		
Environment Temperature	Start-up	-20 °C ~ 50 °C (-4 °F ~ 122 °F)
	Operation	-30 °C ~ 50 °C (-22 °F ~ 122 °F)
Humidity	10% ~ 90% (no condensation)	
Power Source	12V DC / PoE (IEEE 802.3af)	
Max. Power Consumption	11.04 W	
Dimension	Ø 160 x 108.4 mm (6.2 x 4.27")	
Weight	1.2 kg (2.64 lb)	
Ingress Protection	IP66	
Vandal Resistance	IK10	
Regulatory	CE, FCC, RCM, LVD, RoHS compliant	
Power over Ethernet		
PoE Standard	PoE (IEEE 802.3af Power over Ethernet / PD)	
PoE Power Supply Type	End-Span and Mid-Span	
PoE Power Output	Per Port 48V DC, 350 mA. Max. 15.4 watts	

Web Interface	
Installation Management	Web-based configuration
Maintenance	Firmware upgrade through Web Browser or Utility
Access from Web Browser	Camera Live View, Video Recording, Change Video Quality, Bandwidth Control, Image Snapshot, Audio, Picture in Picture, Privacy Mask, Text Overlay
Language	English / Japanese / Simplified Chinese / Traditional Chinese
Applications	
Software Supported	GV-DVR / NVR (V8.7.4.0), GV-VMS (V17.1), GV-Control Center (V3.5.0.0), GV-Edge Recording Manager (V1.3.0.0), GV-Recording Server / Video Gateway (V1.3.0.0) *GV-VMS V17.1 supports Face Detection, Face Recognition and Live View. Other GV-Software only supports Live View.
Smart Device Access	GV-Eye for iOS and Android
Live Viewing	Web browser, Mobile app

Note: Specifications are subject to change without prior notice.

Packing List





- | | |
|--|---|
| 1. H.265 Vandal Proof Dome | 11. Torx Wrench |
| 2. Screw x 4 | 12. Big Concave Hexagon Wrench |
| 3. Screw Anchor x 4 | 13. Small Concave Hexagon Wrench |
| 4. Audio Wires x 2 | 14. Silica Gel Bag |
| 5. I/O Cable | 15. Sticker (for Silica Gel Bag) |
| 6. Installation Sticker | 16. Ruler |
| 7. Conduit Converter | 17. 8 GB Micro SD Card (MLC, SDHC, Class 10) |
| 8. PG21 Conduit Connector | (The Micro SD Card is preinstalled and formatted in the camera) |
| 9. RJ-45 Connector | 18. Download Guide |
| 10. Waterproof Rubber Sets
(for RJ-45 Cat.5 and DC 12V / for RJ-45 Cat.6) | 19. Warranty Card |

Note: Power adapters can be purchased upon request.

Accessories

Model No.	Name		Details
GV-Mount100	Straight Tube and Junction Box Kit		Dimensions: 200 x 170 x 257.5 mm (7.9 x 6.7 x 10.1") Weight: 3.17 kg (6.99 lb)
GV-Mount101	Straight Tube Kit		Dimensions: 219 x 125 x 332 mm (8.6 x 4.9 x 13.1") Weight: 1.8 kg (3.97 lb)
GV-Mount200	Wall Pendant Tube		Dimensions: 225 x 140 x 250 mm (8.9 x 5.5 x 9.8") Weight: 900 g (1.98 lb)

Model No.	Name		Details
GV-Mount203	Wall Pendant Tube and Junction Box Kit		Dimensions: 315 x 195.5 x 225 mm (12.4 x 7.7 x 8.9") Weight: 2.95 kg (6.5 lb)
GV-Mount206	Wall Mount Bracket Kit		Dimensions: 126.5 x 211.3 x 176.85 mm (5 x 8.3 x 6.96") Weight: 0.93 kg (2.06 lb)
GV-Mount300-1	Convex Corner Adapter Kit		Dimensions: 238.6 x 409.5 mm (9.4 x 16.1") Weight: 4.27 kg (9.41 lb)
GV-Mount310-1	Concave Corner Adapter Kit		Dimensions: 123.3 x 393.1 mm (4.9 x 15.5") Weight: 2.96 kg (6.53 lb)
GV-Mount400-1	Pole Mount Bracket Kit (Ø 4 ~ 6")		Bracket: 241 x 161 mm (9.5 x 6.3") Weight: 1.70 kg (3.75 lb) Steel Strap Diameter: Ø 101 ~ 152 mm (4 ~ 6")
GV-Mount410-1	Pole Mount Bracket Kit (Ø 6 ~ 7.5")		Bracket: 241 x 161 mm (9.5 x 6.3") Weight: 1.70 kg (3.75 lb) Steel Strap Diameter: Ø 152 ~ 191 mm (6 ~ 7.5")
GV-Mount702	Extension Tube		Four options are available. Dimensions: Ø 5.4 x 10 or 20 or 30 or 50 cm (Ø 2.1 x 3.9 or 7.9 or 11.8 or 19.7") Weight: 180 g or 390 g or 550 g or 800 g (0.4 lb or 0.86 lb or 1.21lb or 1.76 lb)
GV-Mount903-1	Dome Housing		Dimensions: Ø 185.51 x 165.35 mm (Ø 7.3" x 6.51") Weight: 900 g (1.98 lb)

Model No.	Name		Details
GV-Mount916	In-Ceiling Mount		Dimensions: Ø 205 x 63.8 mm (Ø 8 x 2.5") Weight: 645 g (1.42 lb)
GV-PA191	PoE Adapter		The GV-PA191 is a Power over Ethernet (PoE) adapter designed to provide power to the IP device through a single Ethernet cable.
GV-PoE Switch			The GV-PoE Switch is designed to provide power along with network connection for IP devices. The GV-PoE Switch is available in various models with different numbers and types of ports.
GV-Relay V2			The GV-Relay V2 is designed to expand the voltage load of GV IP devices. It provides 4 relay outputs, and each can be set as normally open (NO) or normally closed (NC) independently as per your requirement.
Metal PG21 Conduit Connector			The metal PG21 conduit connector allows you to run the wires through a 3/4" conduit pipe.
Power Adapter			Contact our sales representatives for the countries and areas supported.